

SINGLE ACTING LOW HEIGHT CYLINDERS, LOAD OR SPRING RETURN



- ✓ Capacities from 10 to 100 ton, strokes up to 150 mm.
- ✓ Two versions: **SP** for load return, and **SMP** for spring return.
- ✓ Low profile for use in confined spaces: machinery positioning, tool fastening, load tests.
- ✓ Body and saddle black nitrided to improve corrosion and wear resistance.
- ✓ Optional tilting saddles can be mounted on 30 to 100 ton models.

Capacity		Stroke	Model	Model	Oil Cap.	A	B	D	E	F	H	K	
ton	kN	mm	LARZEP	LARZEP	cm ³	mm	mm	mm	mm	mm	mm	mm	
10	109	40	SP01004	SMP01004	64	89	129	66	45	36	14*	2	
20	214	40	SP02004	SMP02004	125	101	141	90	63	56	14*	2	
30	303	60	SP03006	SMP03006	265	125	185	102	75	60	14*	2	
50	486	60	SP05006	SMP05006	425	125	185	127	95	80	16*	2	
100	911	60	SP10006	SMP10006	796	141	201	175	130	110	26	2	
		150	-	SMP10015	1.990	254	404	175	130	110	26	2	



SP load return

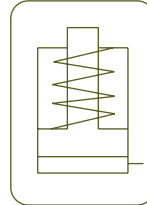
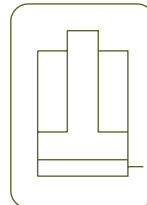
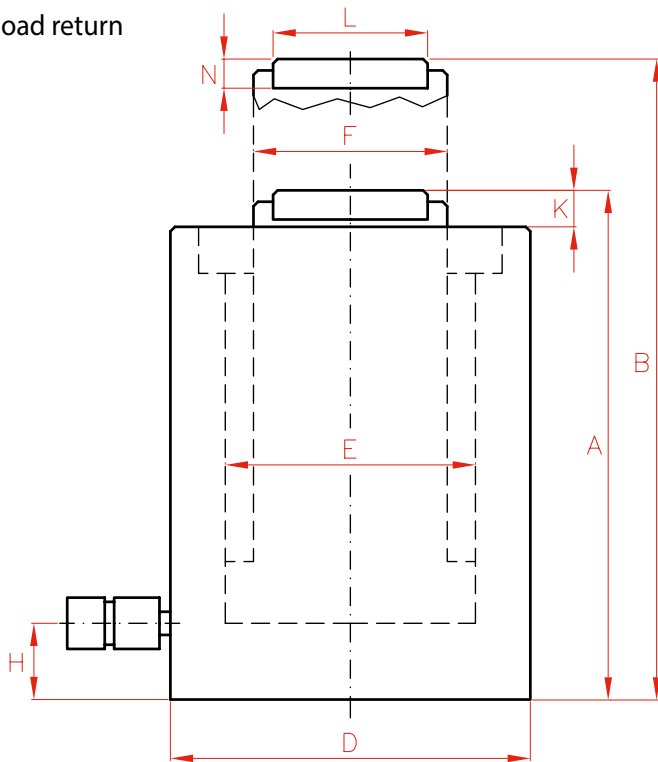

SMP spring return

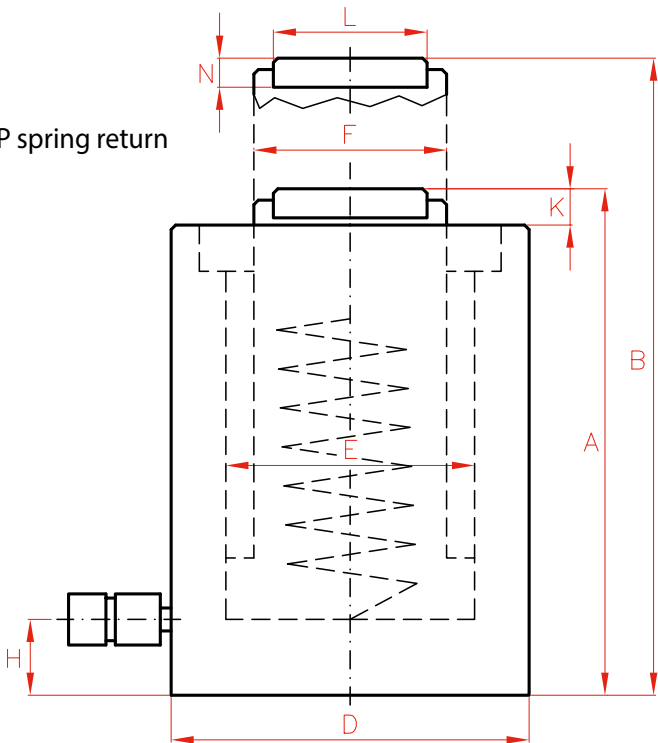

SINGLE ACTING CYLINDERS



Type	SP - SMP
Capacity	10 - 100 ton
Stroke	40 - 150 mm
Max. pressure	700 bar

J Cylinder and pump sets



P.60

SX - SMX Single Acting Low Profile Cylinders



P.24

AZ3 Coupler inclined 10°



P.86

AZ04 Optional Tilting Saddles



P.90

	L	N	Area cm ²	Weight kg	Model	Model	With tilting saddle	
	mm	mm			LARZEP	LARZEP	A	Model
	30	-	16	3	SP01004	SMP01004	-	-
	42	-	31	5	SP02004	SMP02004	-	-
	45	11	44	8	SP03006	SMP03006	150	AZ0401
	61	12	71	12	SP05006	SMP05006	152	AZ0402
	88	14	133	25	SP10006	SMP10006	174	AZ0404
	88	14	133	43	-	SMP10015	287	AZ0404

SINGLE ACTING LOW PROFILE CYLINDERS, LOAD OR SPRING RETURN



- ✓ Capacities from 4 to 150 ton, strokes up to 16 mm.
- ✓ Two versions: **SX** for load return, and **SMX** for spring return.
- ✓ For use in confined spaces: machinery positioning, tool fastening.
- ✓ With two parallel faces for horizontal operation.
- ✓ Mounting bolt holes for easy fixing.
- ✓ Special coating as standard to improve corrosion and side-load resistance.
- ✓ SX models from 50 to 150 ton include removable saddle and can be fitted with optional tilting saddles.

SX & SMX

Coupler inclined 5°, except on 100 ton and 150 ton, which is 0°



P.86

AZ04

Optional Tilting Saddles available for SX models from 50 to 150 ton



P.90

W

Single Acting Hand Pumps



P.66



SX load return

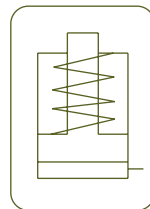
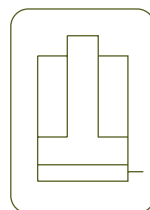
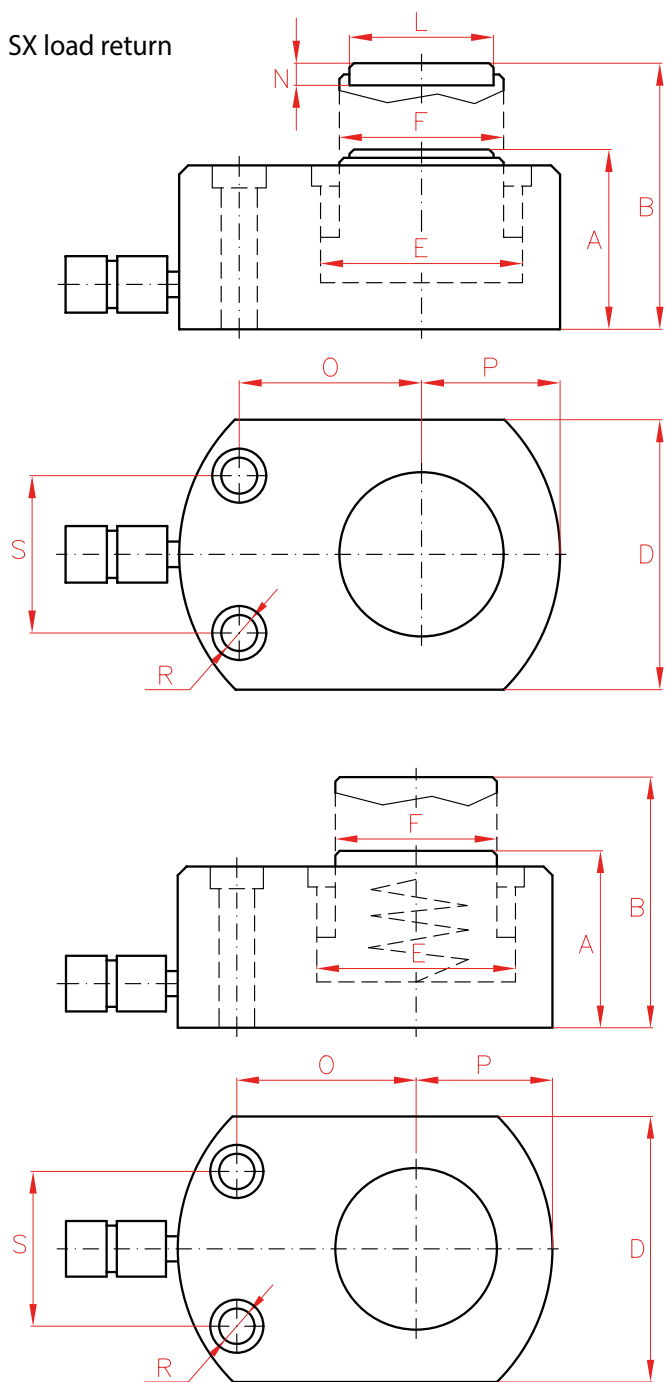

SMX spring return

SINGLE ACTING CYLINDERS



Type **SX - SMX**

Capacity **4 - 150 ton**

Stroke **6 - 16 mm**

Max. pressure **700 bar**

SP - SMP
Low Height Single Acting Cylinders



P.22

STX
Single Acting Pancake Locknut Cylinders



P.32

Capacity		Stroke	Model	Model	Oil Cap.	A	B	D	E	F	L	N	O	P	S	R	Area	Weight
ton	kN	mm	LARZEP	LARZEP	cm ³	mm	mm	mm	mm	mm	mm	mm	mm	mm	mm	mm	cm ²	kg
4	44	6	SX00406	SMX00406	4	33	39	41	28,5	25	21	-	20	21	28	5,5	6	0,8
		16	SX00416	SMX00416	11	43	59	41	28,5	25	21	-	20	21	28	5,5	6	1,2
10	100	11	SX01011	SMX01011	16	43	54	56	43	38	30	-	33	29	37	6,5	15	1,6
22	228	11	SX02211	SMX02211	37	52	63	80	65	57	42	-	39	41	50	9	33	2,8
30	287	13	SX03013	SMX03013	55	59	72	95	73	60	44	-	46	47	52	11	42	4,1
50	487	16	SX05016	SMX05016	114	68	84	114	95	78	61	12	56	58	67	13	71	6,6
75	713	16	SX07516	SMX07516	167	79	95	140	115	95	61	12	66	70,5	75	13	104	12,5
100	954	16	SX10016	SMX10016	223	87	103	162	133	108	88	14	70	89	76	6,6	139	15,0
150	1.450	16	SX15016	SMX15016	338	100	116	194	164	134	88	14	78	108	117	9	211	25,0